

Sefa

Heat Transfer Technologies



2019



Del Conte s.r.l.

Via A. Grandi, 9 / 11
50056 Montelupo F.no - FI
ITALIA

Tel: +39 0571 91 22 85
Fax: +39 0571 91 11 97
E-mail: info@delcontesrl.com

www.delcontesrl.com

CLAM OPENING

04

SWING OPENING

07

DUAL PLATEN

11

SPORT & LOGO

14

LARGE FORMAT

16

COMPRESSORS

20

DTG & INITIUM

21

Perfect heat & pressure distribution
 Plates of 40x50cm
 Ideal for small production or startup
 Optimized dimensions
 Manufactured in France
 2 years warranty on the machine
 10 years warranty on heating element



TECHNICAL CHARACTERISTICS

Weight 44 Kg
 Pressure 254 gr/cm²
 Max Temperature 220°C
 Power Supply 240V single phase
 Electric Power 2500 W
 Amperage 11 A
 Dimensions 857x742x455 mm

ACCESSORIES

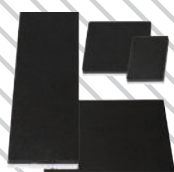

PLA-7A
 Set of 4 plates, useful for precise work.
 Dimensions:
 12 x 8 cm - 15 x 15 cm - 12 x 45 cm
 25 x 30 cm



HOU-50
 Heat resistant NOMEX® cover to protect the lower plate and make the threading easier.

TAB-98-LITE
 Strong support table perfect for SEFA presses.



Electronics developed by Sefa.
 Accurate and fast regulation (PID control) for a wide range of heat transfer products : Flex, flock, sublimation, screen printing transfer.

Advanced electronics
 Double timer (main + pre-heat)
 2 cycle counters, 3 settable programs, Stop cycle function.

From 0 to 570 sec (precision +/- 1%).
 From 0 to 220°C (precision +/- 1%).
 Heating time to reach 180°C : 15 min.

CLAM OPENING

	E-CLAM 50 REL	E-CLAM 50 AUTO
Plate dimensions:	40x50 cm	40x50 cm
Power:	2500 W	2500 W
Weight:	44 Kg	45 Kg
Packaging:	CAI-NO3	CAI-NO3
	Manual closing Manual Opening	Automatic Opening Second Handle

- Perfect heat & pressure distribution
- Drawer plate of 40x50cm
- Ideal for medium production & sports shops
- Optimized dimensions
- 180° reversible C-shaped lower part
- Automatic opening
- Suitable for laser transfers
- « DRY » option to dry direct printing
- Manufactured in France
- 2 years warranty on the machine
- 10 years warranty on heating element

TECHNICAL CHARACTERISTICS

Weight	58 Kg
Pressure	330 gr/cm ²
Max Temperature	220°C
Power Supply	240V single phase
Electric Power	2500 W
Amperage	11 A
Dimensions	969x990x453 mm

ACCESSORIES



PLA-QR
Set of 4 plates, useful for precise work.
Dimensions:
12 x 8 cm - 15 x 15 cm - 12 x 45 cm
25 x 30 cm

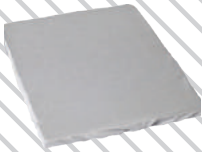

HOU-50
Heat resistant NOMEX® cover to protect the lower plate and make the threading easier.



TAB-98-LITE
Strong support table perfect for SEFA presses.



Front slider plate
For a complete plate clearance
Front slider plate
For a complete plate clearance



Electronics developed by Sefa.
Accurate and fast regulation (PID control) for a wide range of heat transfer products : Flex, flock, sublimation, screen printing transfer.

Advanced electronics
Double timer (main + pre-heat)
2 cycle counters, 3 settable programs, Stop cycle function.

From 0 to 570 sec (precision +/- 1%).
From 0 to 220°C (precision +/- 1%).
Heating time to reach 180°C : 15 min.



180° reversible C-shaped lower part and Quick Release system. To thread T-shirts either from the front or the back of the plate

CLAM OPENING

	CLAM PRO	CLAM PRO GPX
Plate dimensions:	40x50 cm	40x50 cm
Power:	2500 W	3200 W
Weight:	58 Kg	58 Kg
Packaging:	CAI-011	CAI-011
Manual closing Automatic opening Drawer Quick Release		

- Perfect heat & pressure distribution
- Inflatable membrane lower platen to compensate overthickness
- Plates of 40x50cm
- Ideal for small production or startup
- Optimized dimensions
- Manufactured in France
- 2 years warranty on the machine
- 10 years warranty on heating element



TECHNICAL CHARACTERISTICS

Weight	62 Kg
Pressure	600 gr/cm ²
Max Temperature	220°C
Power Supply	240V single phase
Electric Power	2500 W
Amperage	11 A
Dimensions	941x868x442 mm

ACCESSORIES

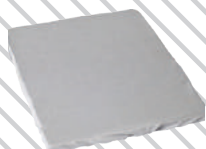

HOU-4555
Heat resistant NOMEX® cover
Enables to thread the T-shirts more easily and protects the foam as well.

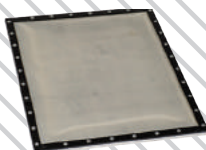

PLA-3035 AIRCLAM
30x35cm membrane plate



TAB-98-LITE
Strong support table perfect for SEFA presses.



Electronics developed by Sefa.
Accurate and fast regulation (PID control) for a wide range of heat transfer products : Flex, flock, sublimation, screen printing transfer.

Advanced electronics
Double timer (main + pre-heat)
2 cycle counters, 3 settable programs, Stop cycle function.

From 0 to 570 sec (precision +/- 1%).
From 0 to 220°C (precision +/- 1%).
Heating time to reach 180°C : 15 min.

CLAM OPENING

AIR CLAM X

Plate dimensions:	40x50 cm
Power:	2500 W
Weight:	62 Kg
Packaging:	CAI-011

Manual closing | Automatic opening
Inflating membrane plate

- User friendly :
- Complete lateral clearance of the plate
- Automatic opening by electromagnet (Lite Version)
- Reversible C-shaped part & Quick Release
- Optimal heat & pressure distribution
- Robust frame
- Suitable for laser transfer applications & sublimation on textile and rigid materials
- Ideal for small to medium productions
- Manufactured in France
- 2 years warranty on the machine
- 10 years warranty on heating plate

TECHNICAL CHARACTERISTICS

Weight	80 Kg
Pressure	590 gr/cm ²
Max Temperature	220°C
Power Supply	240V single phase
Electric Power	2500 W
Amperage	11 A
Dimensions	759x909x569 mm

ACCESSORIES

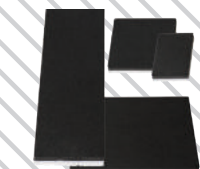

PLA-QR
Set of 4 plates, useful for precise work.
Dimensions:
12 x 8 cm - 15 x 15 cm - 12 x 45 cm
25 x 30 cm

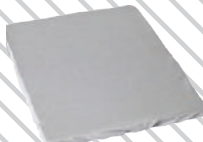

HOU-50
Heat resistant NOMEX® cover to protect the lower plate and make the threading easier.



TAB-98-LITE
Strong support table perfect for SEFA presses.



CROI-161
Laser system to position your transfers with a greater precision.



Electronics developed by Sefa.
Accurate and fast regulation (PID control) for a wide range of heat transfer products : Flex, flock, sublimation, screen printing transfer.

Advanced electronics
Double timer (main + pre-heat)
2 cycle counters, 3 settable programs, Stop cycle function.

From 0 to 570 sec (precision +/- 1%).
From 0 to 220°C (precision +/- 1%).
Heating time to reach 180°C : 15 min.



180° reversible C-shaped lower part and Quick Release system. To thread T-shirts either from the front or the back of the plate

SWING OPENING

	ROTEX ONE	ROTEX LITE
Plate dimensions:	40x50 cm	40x50 cm
Power:	2500 W	2500 W
Weight:	80 Kg	81 Kg
Packaging:	CAI-011	CAI-011
	Manual closing - Manual opening - Manual Rotation	Manual closing - Automatic opening - Manual Rotation

Standard 40x50 cm plate or 45x55 cm in XL version.
 Optimal heat & pressure distribution.
 Robust frame.
 User friendly :
 Complete lateral clearance of the plate.
 Automatic opening by electromagnet.
 Automatic rotation at the end of the cycle.
 Strong pressure for laser application and pretreatment drying.
 Ideal for medium to advanced production.
 Manufactured in France .
 2 years warranty on the machine .
 10 years warranty on the heating plate

TECHNICAL CHARACTERISTICS

Weight	100 Kg
Pressure	562 gr/cm ²
Max Temperature	220°C
Power Supply	240V single phase
Electric Power	3200 W
Amperage	14 A
Dimensions	886x954x624 mm

ACCESSORIES



PLA-QR
 Set of 4 plates, useful for precise work.
 Dimensions:
 12 x 8 cm - 15 x 15 cm - 12 x 45 cm
 25 x 30 cm

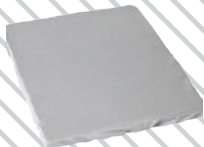

HOU-50
 Heat resistant NOMEX® cover to protect the lower plate and make the threading easier.



TAB-98-LITE
 Strong support table perfect for SEFA presses.



CROI-159
 Laser system to position your transfers with a greater precision.

Plate PLA-DRY M / XL
 40x50cm sponge plate to dry pre treated clothes. 45x55cm for XL version.



User friendly touch screen
 Adaptive regulation parameters depending on the job: flex, sublimation on textile, sublimation on rigid substrates, DTG...
 Advanced electronics
 - 9 recipes menus depending on the job
 - Save up to 5 programs PER recipe
 - Sleep mode
 - Eco mode
 - Double timer (main + pre-heat)
 - Cycle counters
 Stop cycle function .
 From 0 to 600 sec (precision +/- 1%).
 From 15 to 255°C (precision +/- 1%).
 Heating time to reach 180°C : 10 mn.



180° reversible C-shaped lower part and Quick Release system. To thread T-shirts either from the front or the back of the plate

SWING OPENING

	ROTEX PRO	ROTEX PRO XL
Plate dimensions:	40x50 cm	45x55 cm
Power:	3200 W	3200 W
Weight:	100 Kg	112 Kg
Packaging:	CAI-100	CAI-100
Manual closing Automatic opening Automatic rotation Quick release		

Standard plate 40x50cm
 Optimal heat & pressure distribution.
 Comfortable use :
 Complete lateral plate clearance.
 Automatic parallel movement of the heat plate
 Ideal for medium to advanced production.
 Manufactured in France
 2 years warranty on the machine
 10 years warranty on heating element.



TECHNICAL CHARACTERISTICS

Weight	81 Kg
Pressure	400 gr/cm ²
Max Temperature	220°C
Power Supply	240V single phase
Electric Power	2500 W
Amperage	11 A
Dimensions	621x847x572 mm

ACCESSORIES

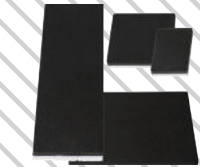

PLA-QR
 Set of 4 plates, useful for precise work.
 Dimensions:
 12 x 8 cm - 15 x 15 cm - 12 x 45 cm
 25 x 30 cm

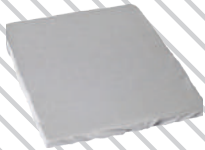

HOU-50
 Heat resistant NOMEX® cover to protect the lower plate and make the threading easier.



TAB-98-LITE
 Strong support table perfect for SEFA presses.



CROI-161
 Laser system to position your transfers with a greater precision.



Electronics developed by Sefa.
 Accurate and fast regulation (PID control) for a wide range of heat transfer products : Flex, flock, sublimation, screen printing transfer.

Advanced electronics
 Double timer (main + pre-heat)
 2 cycle counters, 3 settable programs, Stop cycle function.

From 0 to 570 sec (precision +/- 1%).
 From 0 to 220°C (precision +/- 1%).
 Heating time to reach 180°C : 15 min.



180° reversible C-shaped lower part and Quick Release system. To thread T-shirts either from the front or the back of the plate

ROTEX AIR LITE

Plate dimensions:	40x50 cm
Power:	2500 W
Weight:	81 Kg
Packaging:	CAI-011

Automatic closing | Automatic opening
 Manual rotation

- Standard 40x50 cm plate or 45x55 cm on XL version
- Optimal heat & pressure distribution
- Robust frame
- User friendly :
- Complete lateral clearance of the plate
- Pneumatic closing & opening
- Automatic rotation at the end of the cycle
- Suitable for laser transfer applications & pretreatment drying
- Ideal for medium production
- Manufactured in France
- 2 years warranty on the machine
- 10 years warranty on heating plate

TECHNICAL CHARACTERISTICS

Weight	105 Kg
Pressure	592 gr/cm ²
Max Temperature	220°C
Power Supply	240V single phase
Electric Power	3200 W
Amperage	14 A
Dimensions	680x940x627 mm

ACCESSORIES

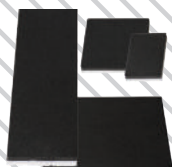

PLA-QR
Set of 4 plates, useful for precise work.
Dimensions:
12 x 8 cm - 15 x 15 cm - 12 x 45 cm
25 x 30 cm

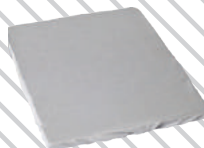

HOU-50
Heat resistant NOMEX® cover to protect the lower plate and make the threading easier.



TAB-98-LITE
Strong support table perfect for SEFA presses.



CROI-159
Laser system to position your transfers with a greater precision.

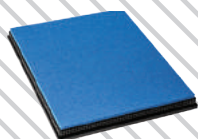

Plate PLA-DRY M / XL
40x50cm sponge plate to dry pretreated clothes. 45x55cm for XL version.



- User friendly touch screen
- Adaptative regulation parameters depending on the job: flex, sublimation on textile, sublimation on rigid substrates, DTG...
- Advanced electronics
 - 9 recipes menus depending on the job
 - Save up to 5 programs PER recipe
 - Sleep mode
 - Eco mode
 - Double timer (main + pre-heat)
 - Cycle counters
- Stop cycle function .
 - From 0 to 600 sec (precision +/- 1%).
 - From 15 to 255°C (precision +/- 1%).
 - Heating time to reach 180°C : 10 mn.



180° reversible C-shaped lower part and Quick Release system
To thread T-shirts either from the front or the back of the plate

SWING OPENING

	ROTEX AIR PRO	ROTEX AIR PRO XL
Plate dimensions:	40x50 cm	45x55 cm
Power:	3200 W	3200 W
Weight:	104 Kg	105 Kg
Packaging:	CAI-100	CAI-100
Automatic closing Automatic opening Automatic rotation Quick release		

- Perfect heat & pressure distribution
- Double plates of 40x50 cm
- Robust frame
- Important height between plates
- User friendly :
- Bi-manual control (+ foot pedal control on Duplex Pro version)
- Touch screen interface
- Automatic translation from one plate to another
- Suitable for laser transfer applications & pretreatment drying
- Ideal for high production
- Manufactured in France
- 2 years warranty on the machine
- 10 years warranty on heating plate

TECHNICAL CHARACTERISTICS

Weight	170 Kg
Pressure	625 gr/cm ²
Max Temperature	255°C
Power Supply	240V single phase
Electric Power	3200 W
Amperage	14 A
Dimensions	713x891x1079 mm

ACCESSORIES

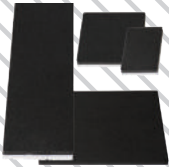

PLA-QR
Set of 4 plates, useful for precise work.
Dimensions:
12 x 8 cm - 15 x 15 cm - 12 x 45 cm
25 x 30 cm

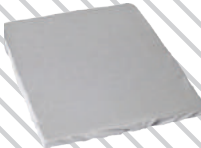

HOU-50
Heat resistant NOMEX® cover to protect the lower plate and make the threading easier.



TAB-98-PRO / R
Strong support table perfect for SEFA presses.



CROI-160
Laser system to position your transfers with a greater precision.

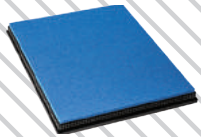

Plate PLA-DRY M / XL
40x50cm sponge plate to dry pre treated clothes. 45x55cm for XL version.



- User friendly touch screen
- Adaptative regulation parameters depending on the job: flex, sublimation on textile, sublimation on rigid substrates, DTG...
- Advanced electronics
 - 9 recipes menus depending on the job
 - Save up to 5 programs PER recipe
 - Sleep mode
 - Eco mode
 - Double timer (main + pre-heat)
 - Cycle counters
- Stop cycle function .
From 0 to 600 sec (precision +/- 1%).
From 15 to 255°C (precision +/- 1%).
Heating time to reach 180°C : 10 mn.



180° reversible C-shaped lower part and Quick Release system
To thread T-shirts either from the front or the back of the plate

DUAL PLATEN

	DUPLEX PRO*	DUPLEX LITE**
Plate dimensions:	40x50 cm	40x50 cm
Power:	3200 W	3200 W
Weight:	170 Kg	158 Kg
Packaging:	CAI-DU-PRO	CAI-DU-PRO
Automatic closing Automatic opening Quick Release Manual rotation of the head* Automatic rotation of the head** 2 push-buttons control Foot pedal control**		

DUPLEX AIR PRO

Hybrid press with membrane plates and aluminum standard plates
 Perfect heat & pressure distribution
 Double plates of 40x50 cm
 Robust frame
 Important height between plates
 User friendly :
 Bi-manual control + foot pedal control
 Touch screen interface
 Automatic translation from one plate to another
 Suitable for laser transfer applications & pretreatment
 Ideal for high production
 Manufactured in France
 2 years warranty on the machine
 10 years warranty on heating plate



TECHNICAL CHARACTERISTICS

Weight	193 Kg
Pressure	625 gr/cm ²
Max Temperature	255°C
Power Supply	240V single phase
Electric Power	3200 W
Amperage	14 A
Dimensions	713x891x1099 mm

ACCESSORIES



PLA-QR
 Set of 4 plates, useful for precise work.
 Dimensions:
 12 x 8 cm - 15 x 15 cm - 12 x 45 cm
 25 x 30 cm

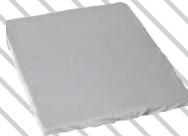

HOU-50
 Heat resistant NOMEX® cover to protect the lower plate and make the threading easier.



TAB-98-PRO / R
 Strong support table perfect for SEFA presses.



CROI-160
 Laser system to position your transfers with a greater precision.

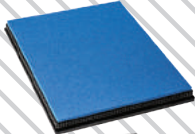
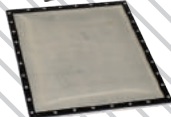

Plate PLA-DRY M / XL
 40x50cm sponge plate to dry pre treated clothes. 45x55cm for XL version.



PLA-3035 AIRCLAM
 30x35cm membrane plate



User friendly touch screen
 Adaptive regulation parameters depending on the job: flex, sublimation on textile, sublimation on rigid substrates, DTG...
 Advanced electronics
 - 9 recipes menus depending on the job
 - Save up to 5 programs PER recipe
 - Sleep mode
 - Eco mode
 - Double timer (main + pre-heat)
 - Cycle counters
 Stop cycle function .
 From 0 to 600 sec (precision +/- 1%).
 From 15 to 255°C (precision +/- 1%).
 Heating time to reach 180°C : 10 mn.



180° reversible C-shaped lower part and Quick Release system
 To thread T-shirts either from the front or the back of the plate

DUAL PLATEN

DUPLEX AIR PRO

Plate dimensions:	40x50 cm
Power:	3200 W
Weight:	193 Kg
Packaging:	CAI-DU-PRO

Same as Duplex Pro + | Inflating membrane plates + aluminum plates

User friendly :
 Bi-manual control + foot pedal control
 Touch screen interface
 Optimum distribution of pressure and heat.
 Small format plate or cap heating element.
 Efficiency and ease of use
 Ideal for advanced production
 Manufactured in France
 2 years warranty on the machine
 10 years warranty on heating element



TECHNICAL CHARACTERISTICS

Weight 60 Kg
 Pressure 993 gr/cm²
 Max Temperature 255°C
 Power Supply 240V single phase
 Electric Power 600 W
 Amperage 3 A
 Dimensions 625x646x941 mm

ACCESSORIES

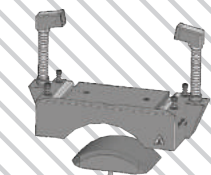

ACC-CAP DUPLEX MINI
 Upper and lower plate for cap for DUPLEX MINI PLA and AUTO PLA

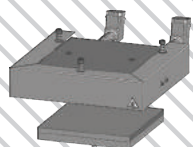

ACC-DUPLEX MINI
 Upper and lower 16x16 cm plate for DUPLEX MINI and AUTO



Special tools included :
 These handles allow to manipulate and hot-swap the elements with safety guaranteed.



User friendly touch screen
 Adaptive regulation parameters depending on the job: flex, sublimation on textile, sublimation on rigid substrates, DTG...
 Advanced electronics
 - 9 recipes menus depending on the job
 - Save up to 5 programs PER recipe
 - Sleep mode
 - Eco mode
 - Double timer (main + pre-heat)
 - Cycle counters
 Stop cycle function .
 From 0 to 600 sec (precision +/- 1%).
 From 15 to 255°C (precision +/- 1%).
 Heating time to reach 180°C : 10 mn.

DUAL PLATEN

	DUPLEX MINI T	DUPLEX AUTO MINI T	DUPLEX MINI PLA T	DUPLEX AUTO MINI PLA T
Plate dimensions:	CAP 18x8 cm	CAP 18x8 cm	PLATE 16x16 cm	PLATE 16x16 cm
Power:	600 W	600 W	600 W	600 W
Weight:	60 Kg	62 Kg	60 Kg	62 Kg
Packaging:	CAI-009	CAI-009	CAI-009	CAI-009
Automatic closing Automatic opening Manual or automatic rotation of the head Foot pedal control (Auto Version)				

CLAM SPORT

- Suitable for balls, caps, logos and shoes
- Quick and tool-free change of elements
- Automatic opening
- Designed and manufactured in France
- 2 years warranty on the machine
- 10 years warranty on the heating element



Electronics developed by Sefa.
Accurate and fast regulation (PID control) for a wide range of heat transfer products : Flex, flock, sublimation, screen printing transfer.

Advanced electronics
Double timer (main + pre-heat)
2 cycle counters, 3 settable programs, Stop cycle function.

From 0 to 570 sec (precision +/- 1%).
From 0 to 220°C (precision +/- 1%).
Heating time to reach 180°C : 15 min.



TECHNICAL CHARACTERISTICS

Weight	24 Kg
Max Temperature	220°C
Power Supply	240V single phase
Electric Power	600 W
Amperage	3 A
Dimensions	899x503x263 mm

ACCESSORIES



ACC-CAP CB
Upper & lower cap accessory for Cap



ACC-SHL CB
Lower logos & shoes accessory for Logo



ACC-BALL
Upper & lower ball accessory for Ball



PLA-6 CB
Flat heating plate for Ball and Logo

QUICK SIZE CHANGE

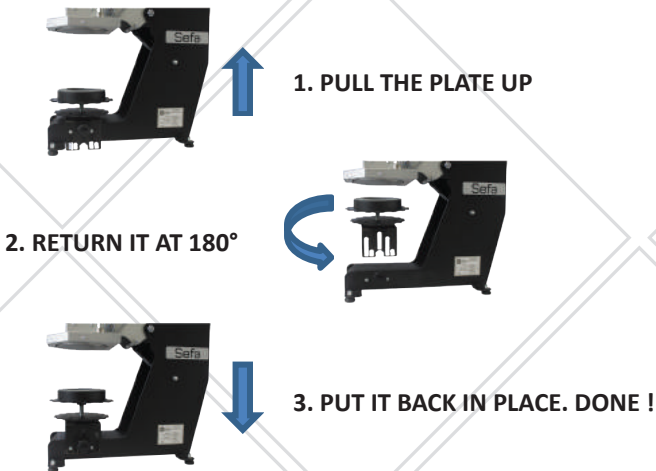

SPORT & LOGO

	CLAM BALL	CLAM LOGO	CLAM CAP
Plate dimensions:	Size 0 to 7 + rugby	Plate 13x13 cm	Cap 17x8 cm
Power:	600 W	600 W	600 W
Weight:	24 Kg	24 Kg	24 Kg
Packaging:	CAI-CLAM BALL	CAI-CLAM BALL	CAI-CLAM BALL

Manual closing | Automatic opening



Perfect heat & pressure distribution
 Ideal for medium production & sports shops
 13x13 cm plate
 Optimized dimensions
 Automatic opening (LE Model)
 Suitable for laser transfers
 Manufactured in France
 2 years warranty on the machine
 10 years warranty on heating element



Electronics developed by Sefa.
 Accurate and fast regulation (PID control) for a wide range of heat transfer products : Flex, flock, sublimation, screen printing transfer

TECHNICAL CHARACTERISTICS

Weight	22 Kg
Pressure	600 gr/cm ²
Max Temperature	220°C
Power Supply	240V single phase
Electric Power	400 W
Amperage	2 A
Dimensions	621x549x233 mm

LP 130 T



User friendly touch screen
 Adaptive regulation parameters depending on the job: flex, sublimation on textile, sublimation on rigid substrates, DTG...

TECHNICAL CHARACTERISTICS

Weight	25 Kg
Pressure	940 gr/cm ²
Max Temperature	255°C
Power Supply	240V single phase
Electric Power	400 W
Amperage	2 A
Dimensions	498x544x274 mm

	LM 130 REL	LE 130 L	LP 130 T
Plate dimensions:	13x13 cm	13x13 cm	13x13 cm
Power:	400 W	400 W	400 W
Weight:	19 Kg	22 Kg	25 Kg
Packaging:	AMERICAN	AMERICAN	AMERICAN
	Manual opening	Auto opening	Full Automatic



High thermal efficiency.
Ideal for sublimation with good productivity and flexibility.

- Fast startup ! (15 to 20min)
- 85x65cm plate in rectified high quality aluminum to sublimate complete 80x60cm plates
- Perfect heat distribution
- 2 years warranty on the machine.
- 10 years warranty on the heating plate
- Manufactured in France.



developed by Sefa.

From 0 to 30 min (precision +/- 1%)

From 0 to 230°C (précision +/- 1%)

Heating time to reach 180°C : 15 min.

Accurate and fast regulation (PID control) for a wide range of heat transfer products: Flex, flock, sublimation, screen printing transfer

- Advanced settings :

- * 4 recordable programs
- * Resettable counter
- * Double timer
- * Eco mode
- * User friendly touch screen
- * Heat sensor PT100

TECHNICAL CHARACTERISTICS

Weight	261 Kg
Pressure	453 gr/cm ²
Max Temperature	230°C
Power Supply	240V single phase
Electric Power	6000 W
Amperage	28 A
Dimensions	794x1756x893 mm

ACCESSORIES



TABL-98 / R
Strong support table perfect for SEFA presses.



TOI-N865
Nomex for rigid substrate



TOI-T865
Teflon for textile process



COMP-74
Compressor for Slide 865.

SLIDE 865

Plate dimensions:	85x65 cm
Power:	6000 W
Voltage:	240V single phase
Amperage:	28 A
Weight:	261 Kg
Packaging:	CAI-SLIDE 1285

Automatic closing | Automatic opening
Manual drawer | 2 independent heating zones



developed by Sefa.

From 0 to 30 min (precision +/- 1%)

From 0 to 230°C (précision +/- 1%)

Heating time to reach 180°C : 15 min.

Accurate and fast regulation (PID control) for a wide range of heat transfer products: Flex, flock, sublimation, screen printing transfer

- Advanced settings :

* 4 recordable programs

* Resettable counter

* Double timer

* Eco mode

* User friendly touch screen

* Heat sensor PT100

High thermal efficiency.

Ideal for sublimation with good productivity and flexibility.

- Fast startup ! (15 to 20min)

- 125x85cm plate in rectified high quality aluminum to sublimate complete 120x80cm plates

- Perfect heat distribution

- 2 years warranty on the machine.

- 10 years warranty on the heating plate

- Manufactured in France.

TECHNICAL CHARACTERISTICS

Weight	419 Kg
Pressure	386 gr/cm ²
Max Temperature	230°C
Power Supply	400V 3-phases
Electric Power	12000 W
Amperage	20 A
Dimensions	794x2153x1286 mm

ACCESSORIES



TABL-98 / R

Strong support table perfect for SEFA presses.



TOI-N1285

Nomex for rigid substrate



TOI-T1285

Teflon for textile process



COMP-111

Compressor for Slide 1285.

SLIDE 1285

Plate dimensions:

125x85 cm

Power:

12000 W

Voltage:

400V 3-phases

Amperage:

20 A

Weight:

419 Kg

Packaging:

CAI-SLIDE 1285

Automatic closing | Automatic opening
Manual drawer | 2 independent heating zones



- High thermal efficiency.
- Ideal for sublimation with good productivity and flexibility
 - Fast startup ! (15 to 20min)
 - Plate sizes: 157x107cm
 - Multizone heating plate for a perfect heat evenness
 - 2 years warranty on the machine
 - 10 years warranty on the heating plate
 - Manufactured in France

TECHNICAL CHARACTERISTICS

Weight	1000 Kg
Pressure	296 gr/cm ²
Max Temperature	220°C
Power Supply	400V 3 phases
Electric Power	20250 W
Amperage	32 A
Dimensions	1370x2740x2019 mm

ACCESSORIES



ASP-SUBLI
Exhaust system for Subli



COMP-240
Compressor for Subli1510

*Packaging not included. Please refer to page 22 for compulsory options, accessories prices & packaging



Developed by Sefa.

- Accurate and fast regulation (PID control) for a wide range of heat transfer products :
- * Sublimation on textile (sports articles, flags, banners...)
- * Sublimation on rigid substrates (aluminum, MDF for photos transfers)
- Multizones temperature adjustment
- Multilingual interface.
- From 0 to 220°C (precision +/- 0.5%)
- Heating time to reach 180°C : 15 min

LARGE FORMAT

	SUBLI 1510+	SUBLITEX 1510+
Plate dimensions:	157x107 cm	157x107 cm
Power:	20250 W	20250 W
Voltage:	400V 3-phases	400V 3-phases
Amperage:	32A	32A
Weight:	1000 Kg	1000 Kg
Packaging:	CAI-SUBLI	CAI-SUBLI

Specific electronics to able sublimation on rigid substrates & textiles (SUBLI 1510+) | Double motorized drawer plates | 2 independent heating zones



- High thermal efficiency.
- Ideal for sublimation with good productivity and flexibility
- Multizone heating plate for a perfect heat evenness
- Fast startup! (15 to 20min)
- Plates sizes :
 - 180 x 120 cm
 - 255 x 130 cm
- Manufactured in France
- 2 years warranty on the machine
- 10 years warranty on heating elements

TECHNICAL CHARACTERISTICS (1812 - 2513)

Weight	1394 Kg - 2180 Kg
Pressure	378 gr/cm ² - 318 gr/cm ²
Max Temperature	220°C
Power Supply	400V 3 phases
Electric Power	30250 W - 35000 W
Amperage	46 A - 56 A
Dimensions	1396x3000x2249 mm (1812)
	1446x3202x3007 mm (2513)

ACCESSORIES



ASP-SUBLI
Exhaust system for Subli

COMP-300
Compressor for SubliMax 1812

*Packaging not included. Please refer to page 22 for compulsory options, accessories prices & packaging



Developed by Sefa.

- Accurate and fast regulation (PID control) for a wide range of heat transfer products :
 - * Sublimation on textile (sports articles, flags, banners...)
 - * Sublimation on rigid substrates (aluminum, MDF for photos transfers)
- Multizones temperature adjustment
- Multilingual interface.
- From 0 to 220°C (precision +/- 0.5%)
- Heating time to reach 180°C : 15 min

LARGE FORMAT

	SUBLIMAX 1812	SUBLITEX 1812	SUBLIMAXI 2513
Plate dimensions:	180x120 cm	180x120 cm	255x130 cm
Power:	30250 W	30250 W	35000 W
Voltage:	400V 3-phases	400V 3-phases	400V 3-phases
Amperage:	46A	46A	56A
Weight:	1394 Kg	1388 Kg	2180 Kg
Packaging:	CAI-SUBLI	CAI-SUBLI	CAI-SUBLI

Specific electronics to able sublimation on rigid substrates & textiles | Double motorized drawer plates | 4 independent heating zones (2 on SubliTEX) | Nomex attached on the heating plate

Machine reference	Advised compressor
AIR CLAM X	COMP-37
ROTEX AIR LITE	COMP-37
ROTEX AIR PRO / XL	COMP-74
DUPLEX LITE	COMP-74
DUPLEX PRO	COMP-111
DUPLEX AIR PRO	COMP-111
LP 130 T	COMP-37
DUPLEX MINI T / PLAT	COMP-37
DUPLEX AUTO MINI T / PLAT	COMP-37
SLIDE 865	COMP-74
SLIDE 1285	COMP-111
SUBLI / TEX 1510+	COMP-240
SUBLI / TEX 1812	COMP-300
SUBLIMAXI 2513	400L/min - Tank of 250 liters

Compressor		Sound	Tank	Air Flow	Dimensions	Weight
COMP-37		40 dB(A)	24 L	37 L/min	49x46x57 cm	30 Kg
COMP-74		42 dB(A)	24 L	74 L/min	80x39x65 cm	46 Kg
COMP-111		42 dB(A)	50 L	111 L/min	91x45x67 cm	73 Kg
COMP-240		42 dB(A)	50 L	240 L/min	114x38x76 cm	90 Kg
COMP-300		79 dB(A)	150 L	300 L/min	127x53x87 cm	129 Kg



Ideal for continuous production.
Optimize your direct to garment printings on dark T-shirts.
Consistent and uniform pre-treatment spraying.
Centralization of all the parameters on the user friendly touch screen.
Automatic cleaning cycle and nozzle moisturizing.
2 Years warranty.
Made in France.

ISPRAY 2

Plate dimensions: 40x50 cm
Power: 300 W
Packaging: CAI-ISPRAY2

Manual drawer
2 nozzles | Automatic cleaning

TECHNICAL CHARACTERISTICS

Weight 95 Kg
Power Supply 230V single phase + Gr
Electric Power 300 W
Amperage 1,3 A
Dimensions 600x1570x645 mm

Specially assembled for dtg ink drying
Perfect heat distribution
Very high quality and strong body
Variable feed speed and air flow
2 year guarantee on the machine
10 year guarantee on heating elements
Manufactured in France.

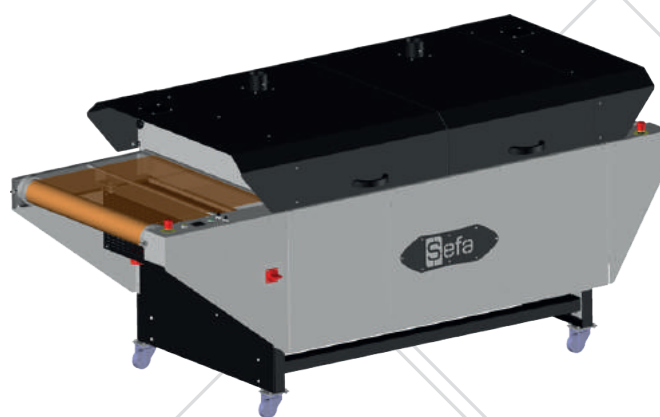

TUN DTG

Dimensions: 2560 x 1200 x 1240 mm
Max. air flow : 700 m3/h.
Power: 12000 W
Weight: 387 kg

Variable Speed | Variable Air Flow
Special DTG inks



INITIUM



IMUG S

Plate dimensions: Ø80
Power: 400 W
Weight: 8 Kg

1 year warranty

IMUG C

Plate dimensions: Ø80
Power: 400 W
Weight: 5 Kg

ICAP 2

Plate dimensions: 14x8cm*
Power: 600 W
Weight: 20 Kg

* Logo plate 15x20 cm provided

Explore the complete range

Online registration

Accessories and technical datasheet

Find your distributor

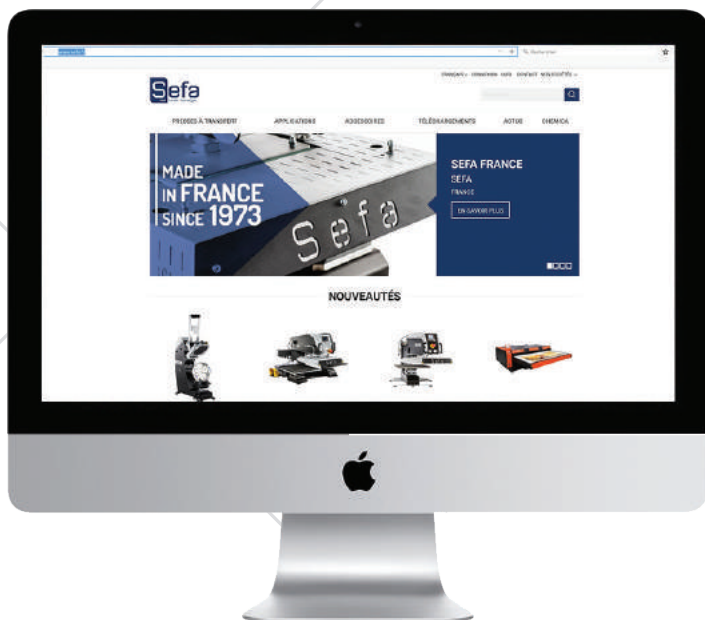
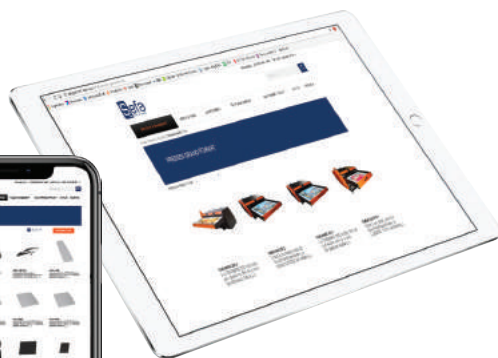

And much more at

www.sefa.fr

THEY PUT THEIR TRUST IN US !



JORDAN

ChromaLuxe[®]
True to your vision



SAWGRASS[™]
THE ART OF WHAT'S NEXT

DECATHLON



 **Fanatics**

adidas



 **HERMÈS**
PARIS



 **RUGBY**[™]
DIVISION

EPSON
EXCEED YOUR VISION

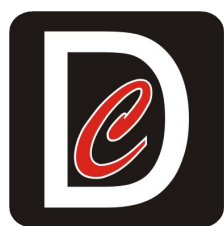

Del Conte s.r.l.

Via A. Grandi, 9 / 11
50056 Montelupo F.no - FI
ITALIA

Tel: +39 0571 91 22 85
Fax: +39 0571 91 11 97
E-mail: info@delcontesrl.com

www.delcontesrl.com

The logo for FLEXDEV GROUP, featuring a stylized 'F' and 'D' in blue and orange. To the right of the logo, the text "Sefa is a company of" is written in a small, blue sans-serif font, followed by "FLEXDEV" in a larger, bold, blue sans-serif font, and "GROUP" in a smaller, blue sans-serif font below it.

Sefa is a company of
FLEXDEV
GROUP